



PARIS

A reform of stalls and terraces in Paris:



Christophe Jacquet / Ville de Paris

we explain everything!

At the end of a period

exceptional and particularly difficult for Parisians and shopkeepers, Parisian life is back!

The shops that make up the soul of Paris have finally reopened their doors to delighted customers.

If, in June 2020, it was necessary to adapt quickly to the context in order to protect the health of customers and support merchants with relaxed rules, it is now necessary to clarify and frame the new uses imposed by the health crisis.

Following a consultation process involving more than 500 participants, professionals, street users' associations and local residents, a reform of the rules governing stalls and terraces will be introduced and will apply to all on 1 July 2021.

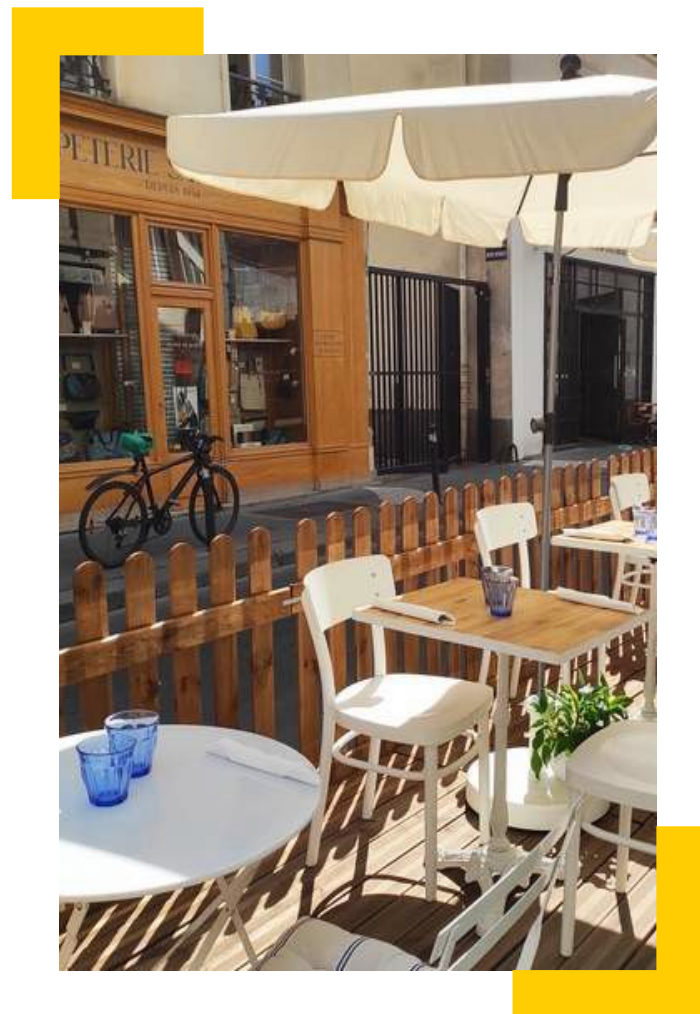

Rebalancing occupancy of public space and in particular of parking spaces for the benefit of pedestrians and new uses.

Protect

Parisians by encouraging the opening of outdoor shops as part of the fight against terrorism.
the spread of Covid-19

Support

our merchants who make the richness and identity of our neighbourhoods

Answer

to the expectations of local residents, professionals and elected officials, particularly in terms of regulation and control noise pollution

What's new

1

New terraces from April to October on the sidewalks, medians, plazas, and temporarily pedestrianized streets

2

Cultural shops (terrace for hotels, record shops and bookshops), hotels and florists will be able to install terraces and stalls on parking spaces

3

All terraces, annual or summer events, must now be authorized with the reasoned opinion of the district mayor

4

Summer terraces will now have an aesthetic framework to respect

All terraces will now have to be authorized: the procedure

The permits are issued by the city of Paris on a personal and temporary basis. They are precarious and revocable, even if they are tacitly renewable each year.

They may not be transferred. In the event of a change of activity, change of ownership or renovation, a new permit must be applied for.

The installations are subject to the payment of road fees. Their control is carried out by the sworn agents of the city of Paris and the Préfecture de Police. Failure to comply with the regulations may result in fines and the withdrawal of authorizations.

General information on displays and terraces in Paris on :

paris.fr

The locations accepted for the summer terraces in agreement and in the respect of the needs of the other traders present:

- Medians
- Plots
- Temporarily pedestrianized streets
- On the parking lot in front of the business with a possible extension on an additional parking space on both sides
- On the side with the written consent of the neighbouring merchant

Maintain pedestrian paths and accessibility for people with reduced mobility

- Maintain a minimum of 1.60m of passage
- Passes to 1m80 between terrace and counter terrace

Focus on accepted summer locations on the sidewalks

- To commercial law
- 1 number on each side with the possibility of extending only in front of blind walls and in front of businesses that have given their prior written permission, but without hindering their access and evacuation

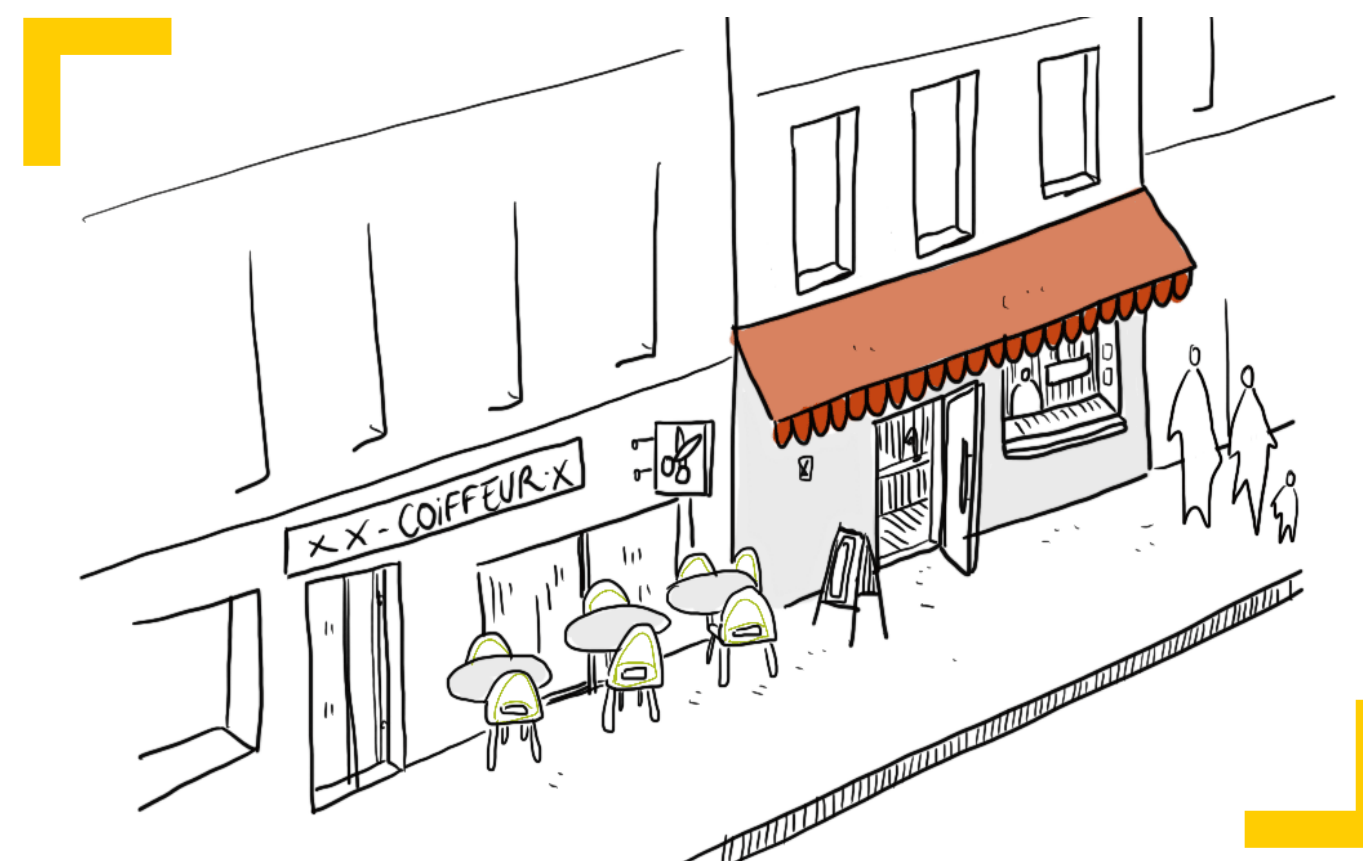
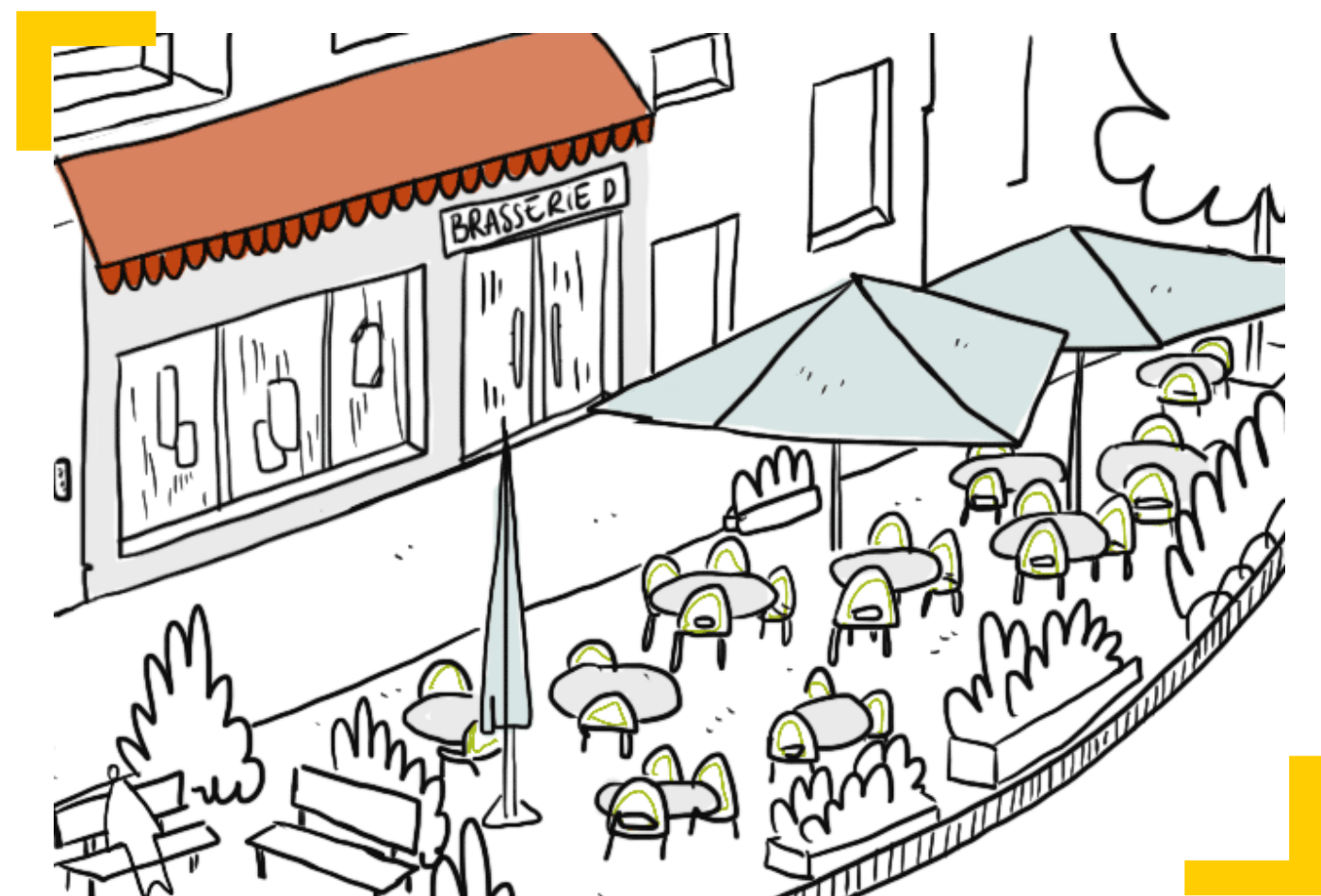

Conditions of operation of summer terraces and annual

Estivales

- Annually from April 1 to October 31
- The hours: the operation of summer terraces will be authorized until 10 pm, unless a problem is identified with the establishment
- Tacit renewal each year, except in case of necessity linked to works or particular events on the public space
- Complete disassembly of installation at the end of the season to November 1st. The furniture must be put away after hours of operation



Annual

- The period: all year round
- The hours: until 2am
- Installation now possible on parking
- Tacit renewal each year, except in case of necessity linked to works on the public space or particular events on the public space

Prohibited installations of summer terraces

- Electrical installations (lighting, heating, etc.)
- Advertising
- Opaque elements
- The elements must not be fixed to the ground
- Roofing: roofs, tarpaulins, barnacles
- The use of pallet wood
- Floors and all floor coverings on sidewalks

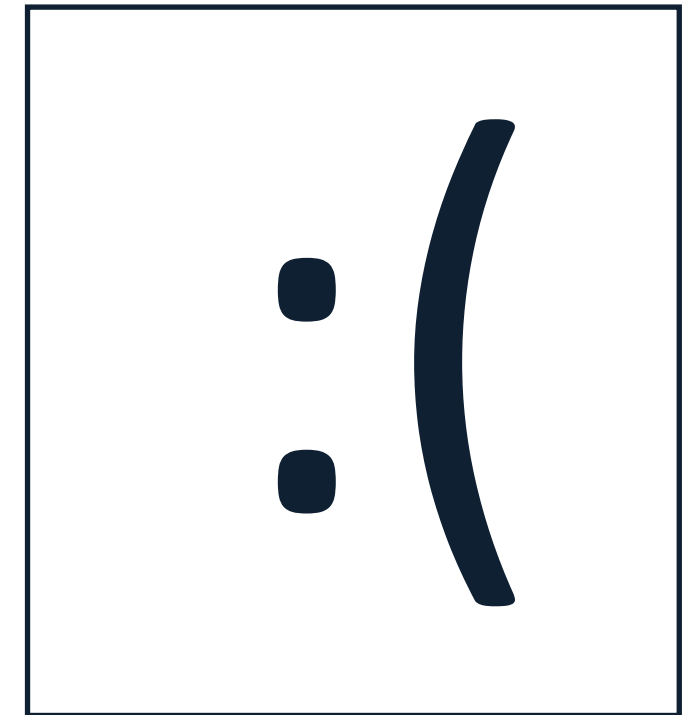

The respect of public peace and quiet and the life of the neighbourhood is an essential commitment to guarantee the functioning of its terrace

- No music in outdoor areas
- No amplified music since Inside the business
- Ensure that noise pollution from its customers is limited by respecting operating hours

Which terraces are concerned on parking ?

Which terraces are affected by parking?

- Summer terraces
- Year-round terraces

Accepted locations

- On the right of the business with possible extension on an additional parking space on both sides (1 parking space=10m²)

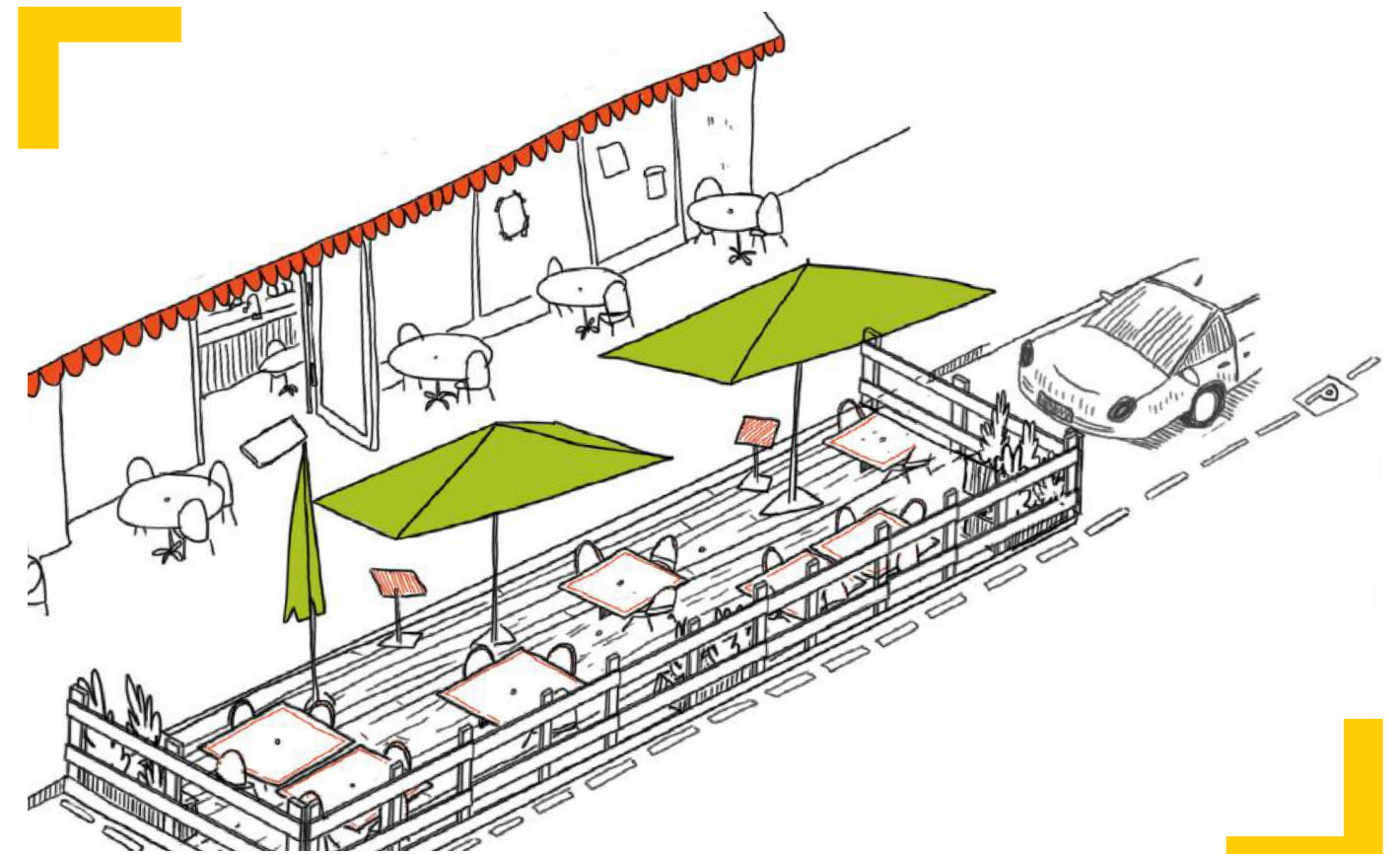

General provisions

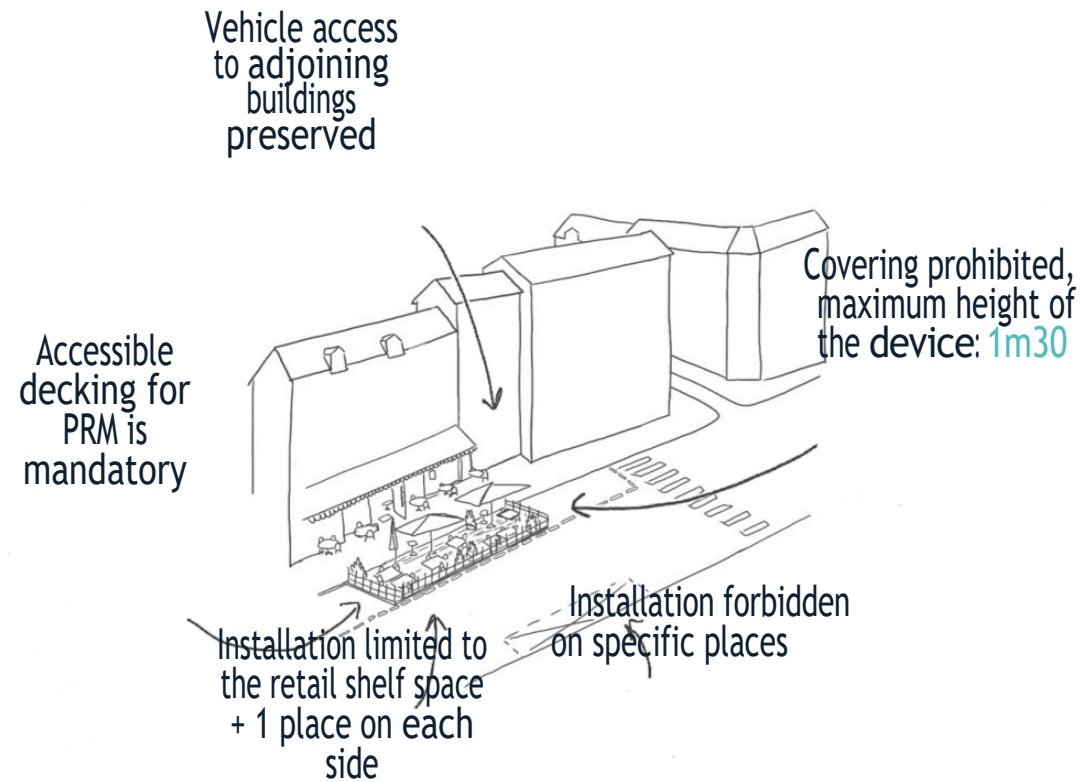

Technical requirements

- To ensure accessibility for people with reduced mobility, a wooden decking only, aligned with the height of the pavement, will be installed, without fixing on it or the roadway, and without any free space left with the curb
- To maintain the drainage of waste water, a free space under the decking of a minimum width of 25 cm will be provided along the gutter

- The white line delimiting the parking area must remain visible to motorists
- For the safety of users, side protection barriers and on the traffic side, with a maximum height of 1.30 m and perforated so as not to obscure visibility, must be fixed to the decking
- The installation must ensure sufficient width for the passage of cleaning equipment
- Cleaning around the terrace is done by the merchant

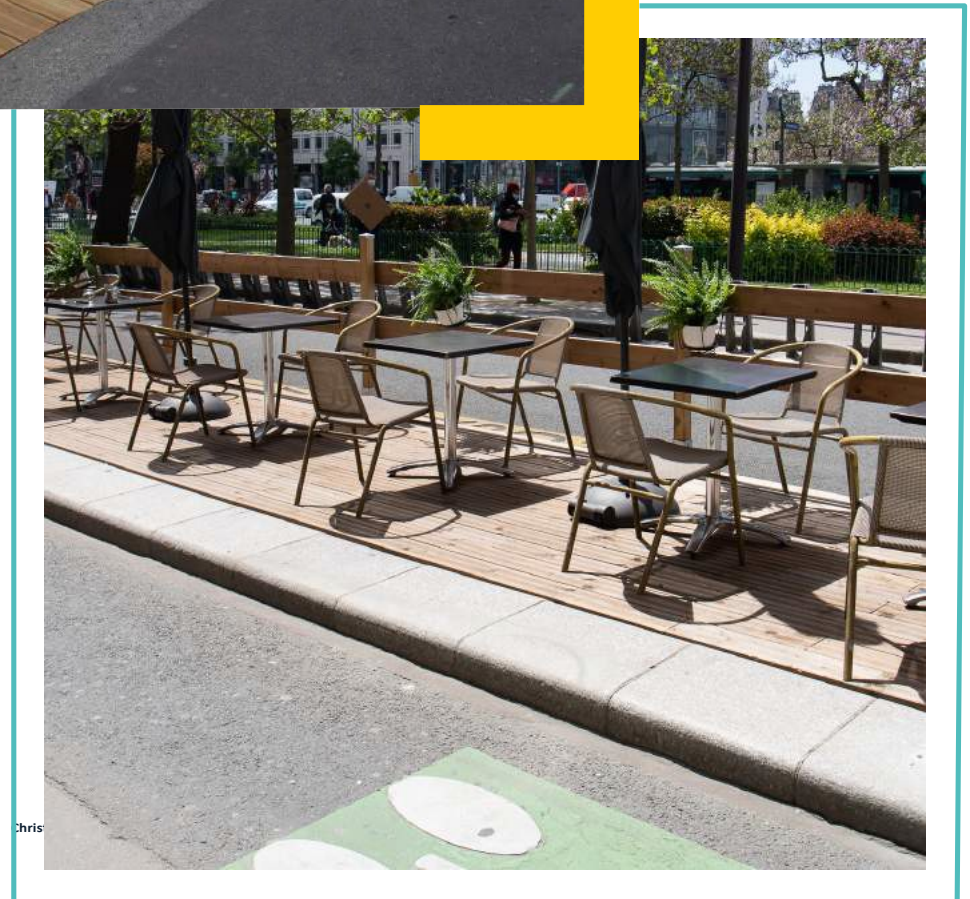

The decking

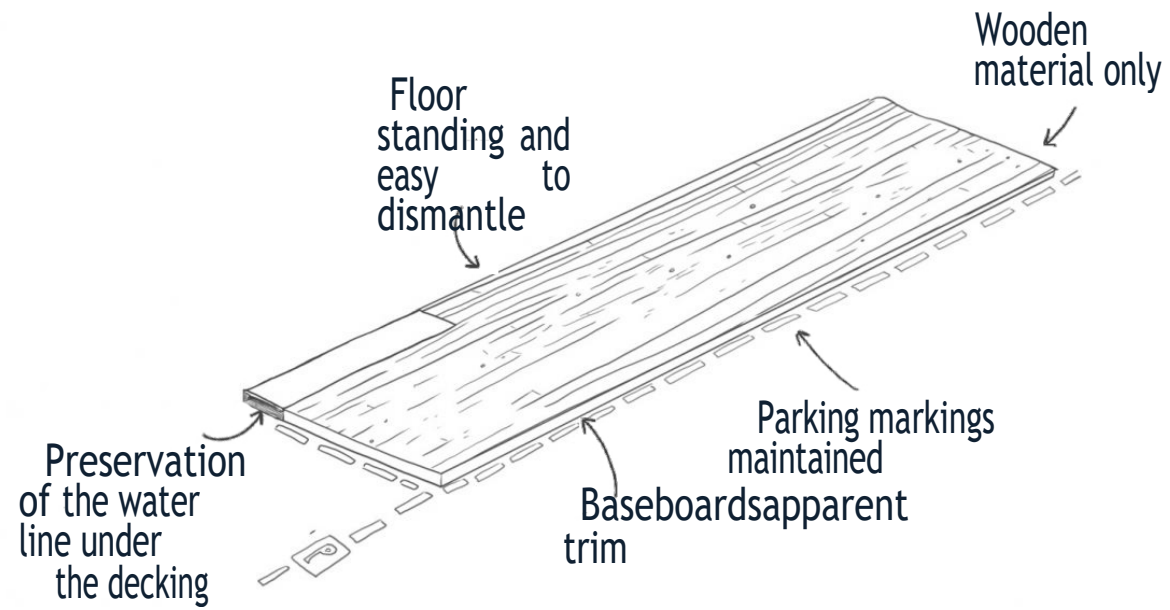

Protective barriers

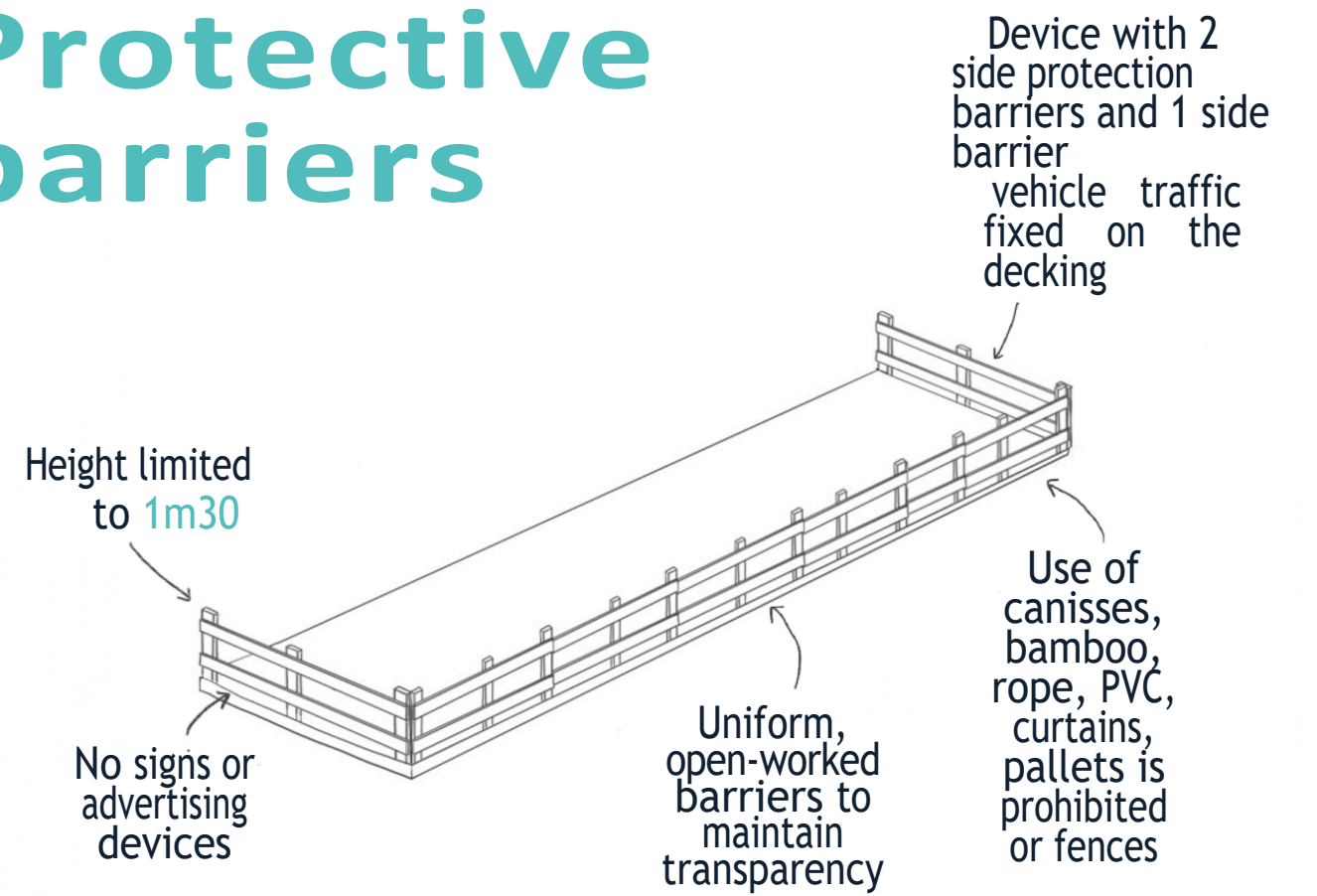

Christophe Jacquet / Ville de Paris



Christophe Jacquet / Ville de Paris

The vegetation

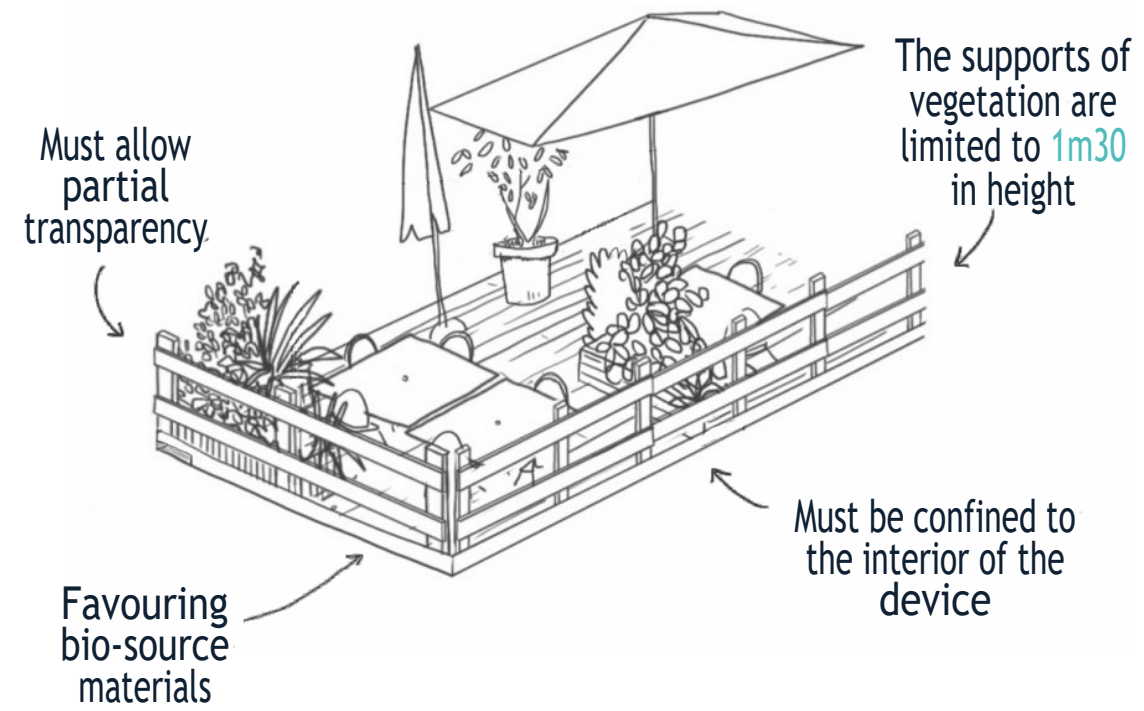

Aesthetic recommendations

○ Greening is strongly encouraged, but without making it totally opaque

○ The barriers must be uniform and of a sober colour in order to blend harmoniously into the landscape of the street



Christophe Jacquet / Ville de Paris

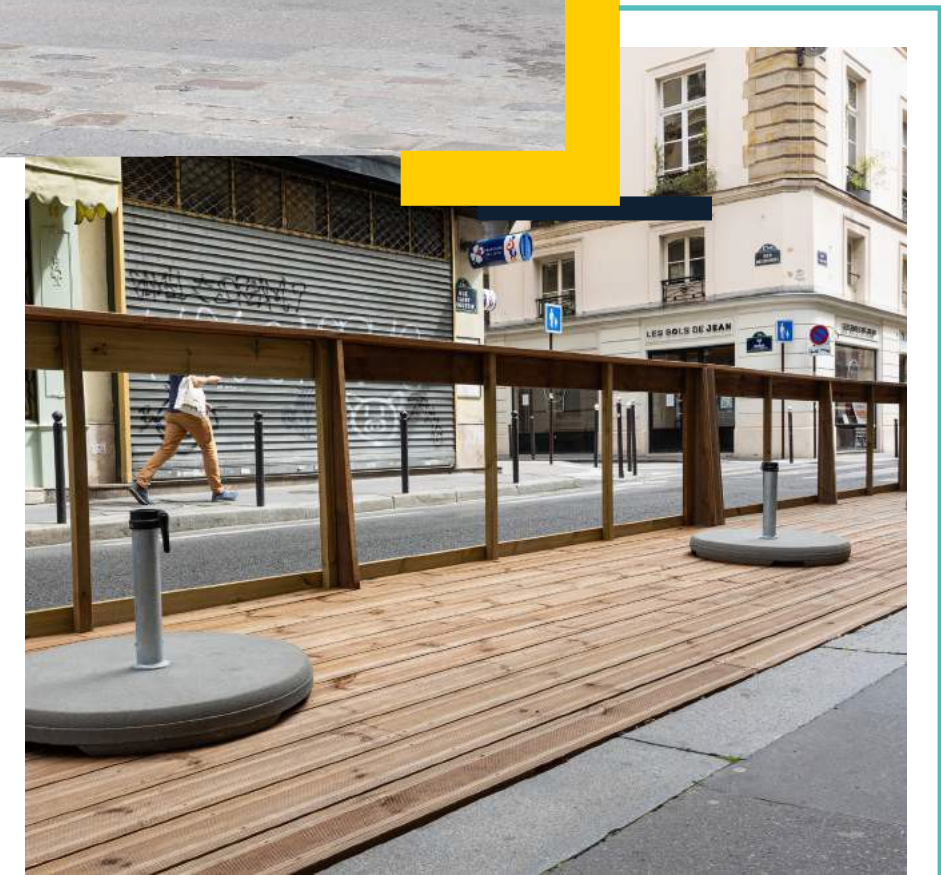

Guillaume Bontemps / Ville de Paris

Furniture on the parking lot

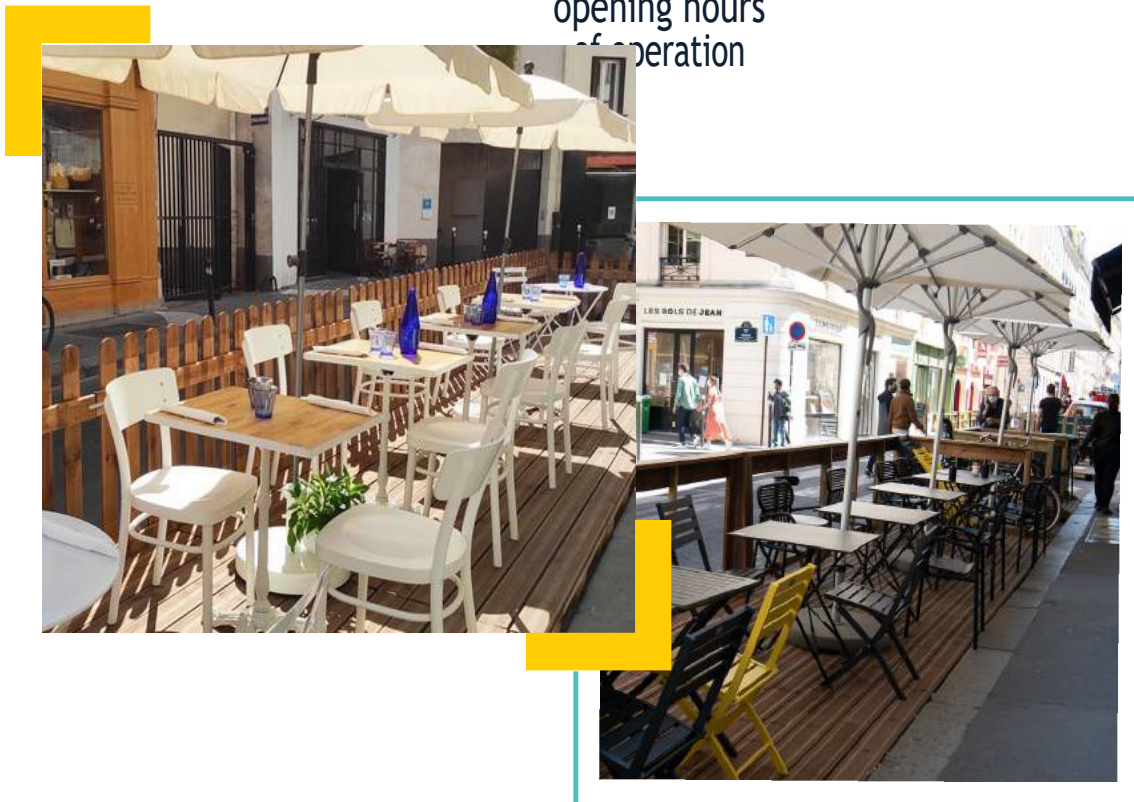
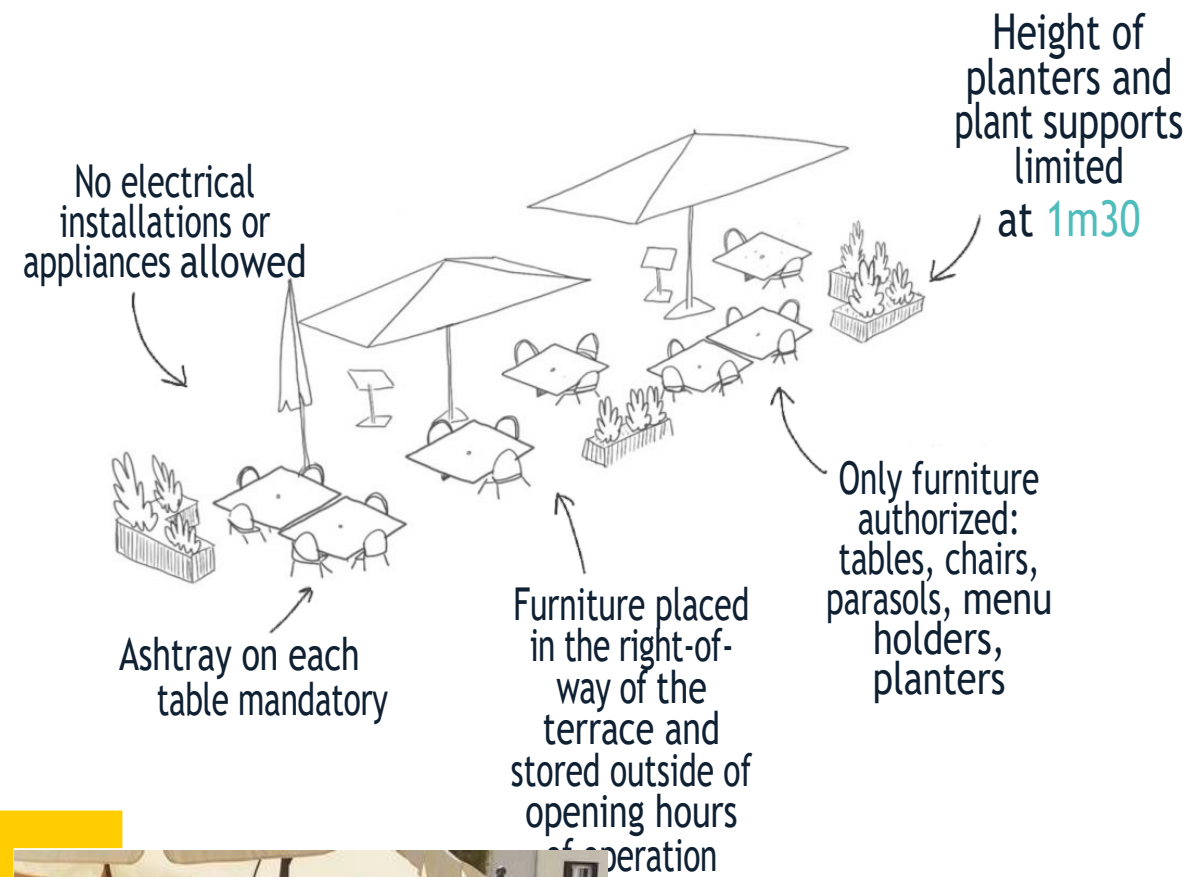

Christophe Jacquet / Ville de Paris

Prohibitions on terraces on parking spaces

- Installations on reserved parking (delivery space ; place for people with reduced mobility; place for 2 wheels; motorcycles and scooters; taxis; bicycle station; scooters; Mobilib; cash in transit)
- Covering devices: roofs, tarpaulins, or barnacles
- Fences made of pallets, canisse, bamboo, rope, pvc, netting
- Electrical appliances or installations (misting device, lighting, spotlight, ...)
- No signs or advertising will be hung on the barriers or written on the furniture (parasols in particular)

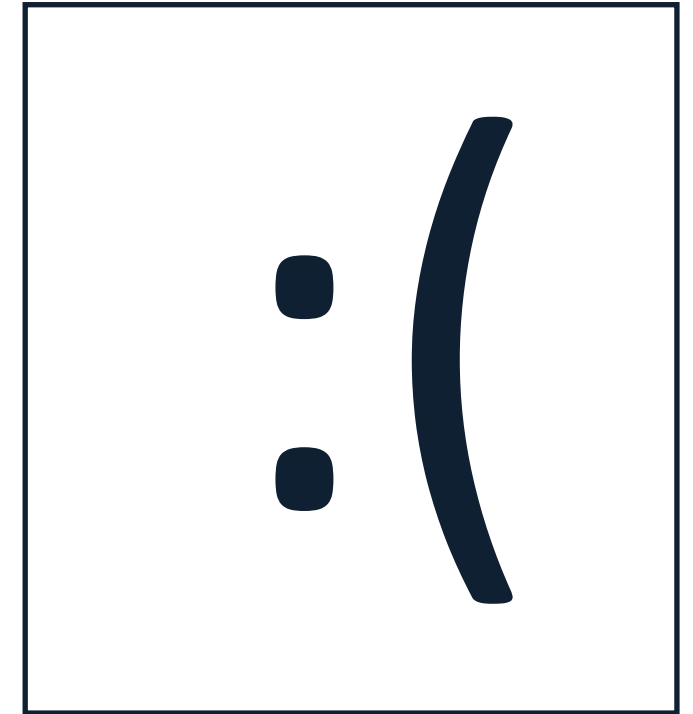

What happens in case of non-compliance of these rules?

To report a violation or nuisance

Use In My Street to report a terrace

The scale of penalties

A progressive scale of sanctions will be created, ranging from a simple warning to a fine, the temporary or definitive withdrawal of the operating permit for the terrace, and until the official request to the Prefecture of Police for the administrative closure of the institution. Will also be put implementing the new administrative fine regime of up to 500€.

Reasoned warning to the head of the establishment

Ticketing from 68€ to 500€ depending on the type of offence

Restriction of the hours of operation of the facility for a variable period of time depending on the seriousness of the acts observed or the repetition or persistence of the acts

Reasoned suspension of the terrace permit for a period of time that varies according to the seriousness of the facts (15 days, 1 month or 2 months, and possible doubling in case of repetition or persistence of the facts)

Permanent withdrawal of the terrace

The penalty scale will be applied in cases of :

- Installation of a terrace without authorization (or after motivated refusal by the City)
- Non-compliance with the limits of the terrace permit
- Terrace in front of a ground floor dwelling or in front of a business without its authorization
- Establishment on an essential public space: PMR parking, deliveries, bicycle lanes, bus lane, scooters and motorcycles
- Non-respect of the closing hours of the summer terraces
- Non-respect of pedestrian pathways

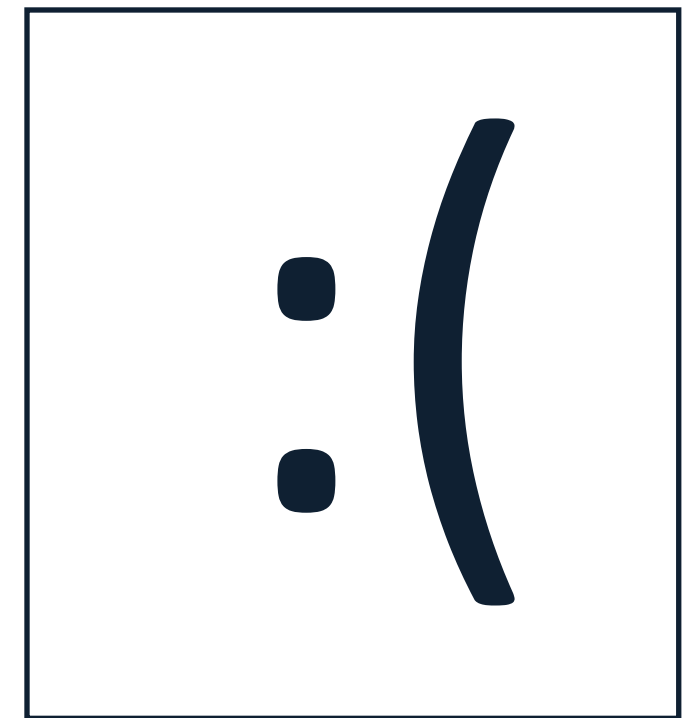

- Noise pollution and emission of amplified music from inside the building
- Installation without measurements safety or safety risk in relation to the sidewalk or roadway
- Y No removal of the deck at the end of the summer season
- Installation of a closed volume construction
- Non-maintenance of the deck + installation of a closed construction

permit for a period of up to 3 years

Terrace memo

Terrace

Closed

A delimited occupation of the public domain, covered and closed, intended for the clientele of the business in front of which it is immediately established. Closed terraces must be removable.

Open

Delimited occupation of the public domain of the roadway for the purpose of catering to customers of the business in front of which it is immediately established. Open terraces must be removable.

Summer

Seasonal extension on sidewalk, square, median, parking lot, or pedestrianized street, with a limited installation period.

Counter terrace

A counter terrace shall be separated from the facade or the shop front in front of which it is established by a free passage of at least 1.80 m wide for pedestrians.

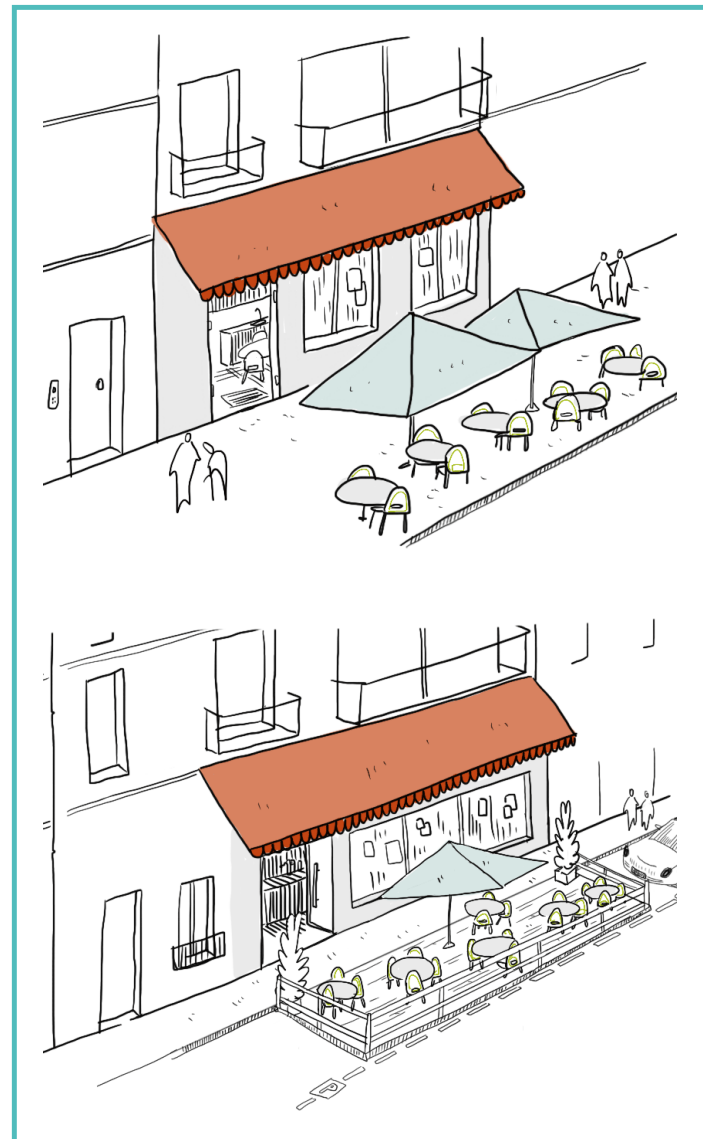

What's next?

I already have a terrace declared during the sanitary crisis valid until June 30th, what do I have to do a new request of summer terrace as of July 1, 2021?

Yes, in any case, to benefit from a terrace from July, you must apply for permission [here](#).

I have applied for a summer terrace, when can I set up?

As soon as I receive the receipt that allows me to set up temporarily - pending the final authorization after the examination of the request by the City services, Prefecture and Mayor of the district.

Illustrations
Lou Cartet-Dupuy
lou.projets@mailo.com



Graphic design
DICOM Graphics Studio